

New Fall skirt

Center front

Cut 1

Size 10

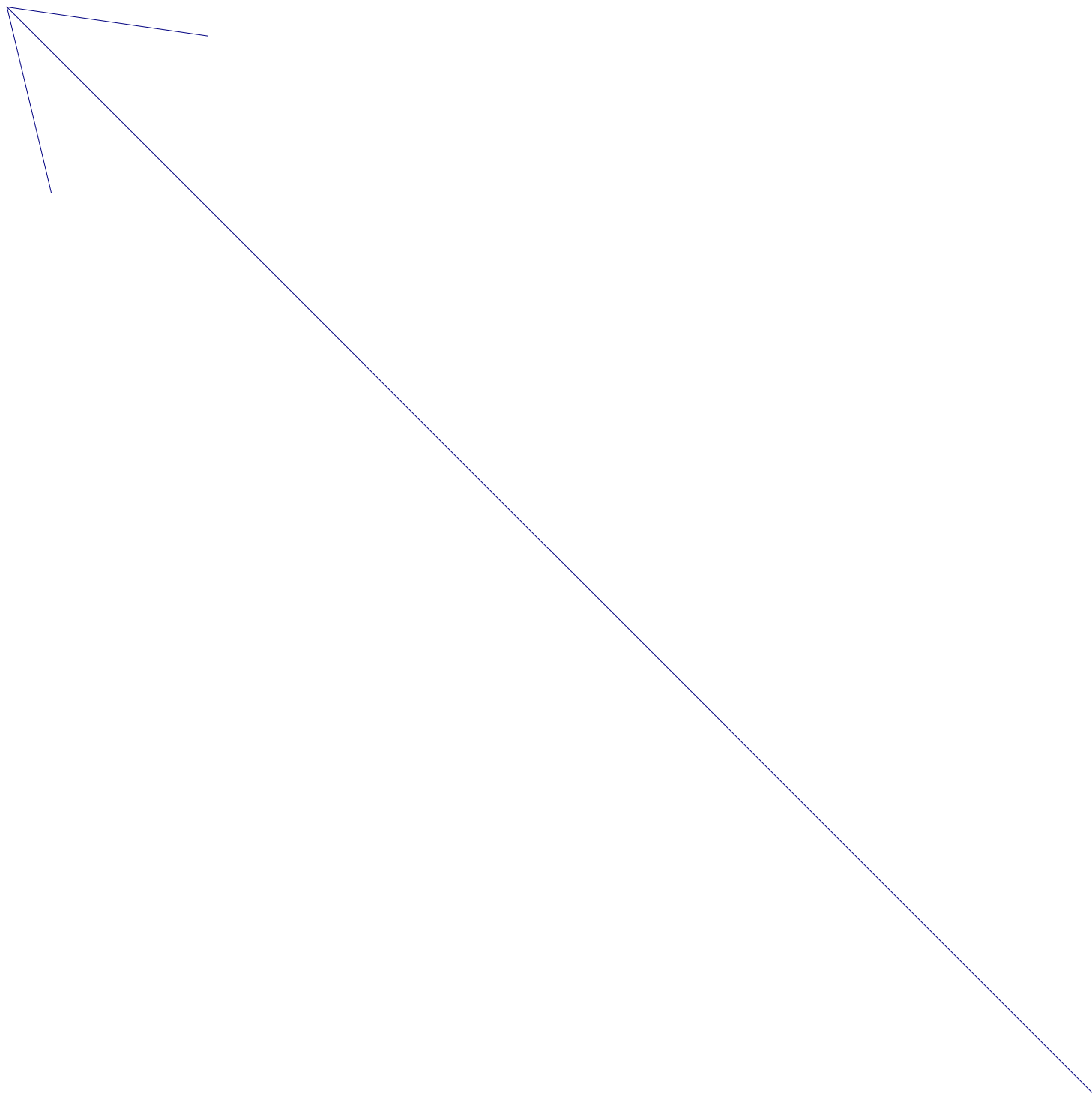

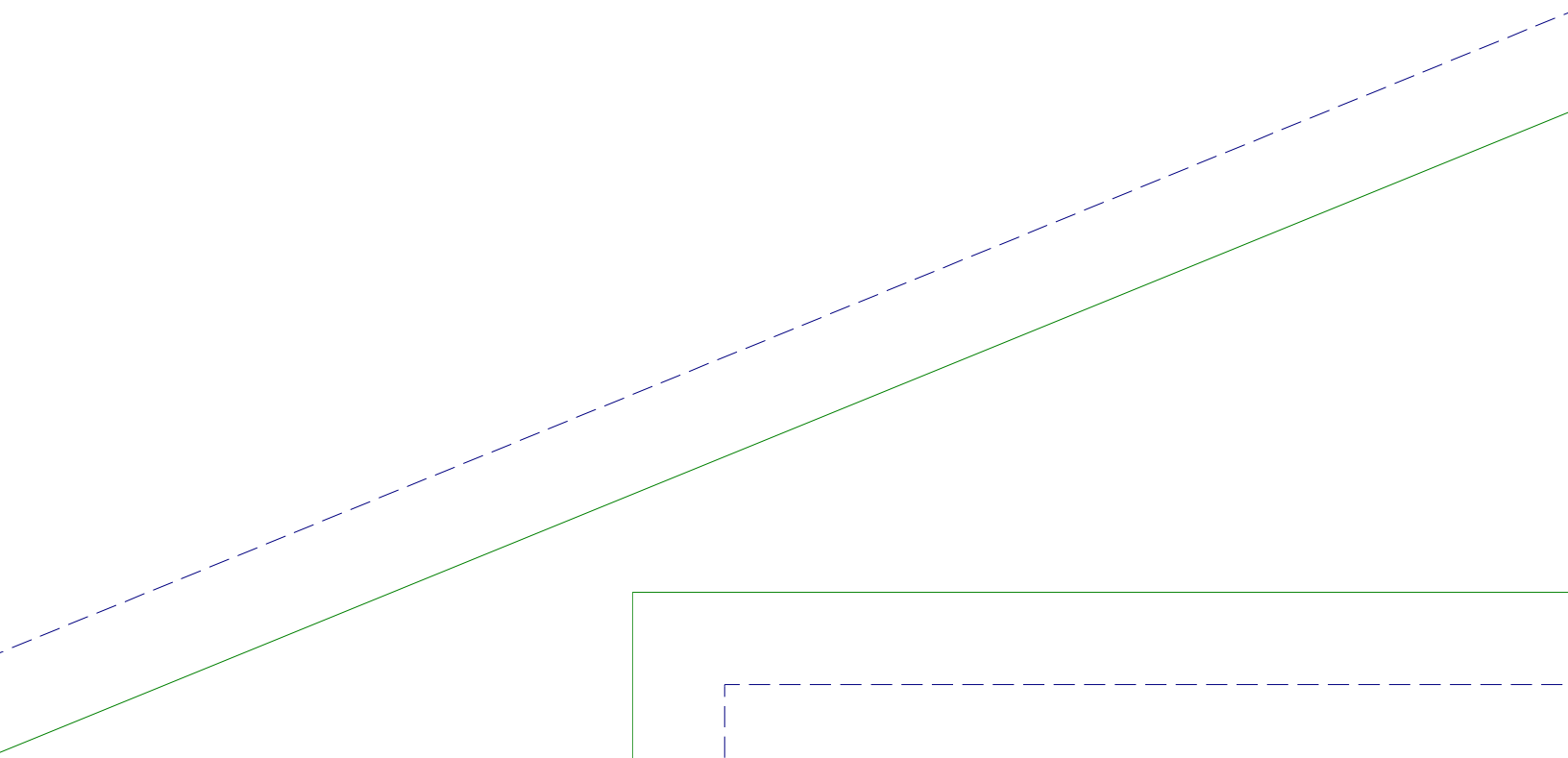

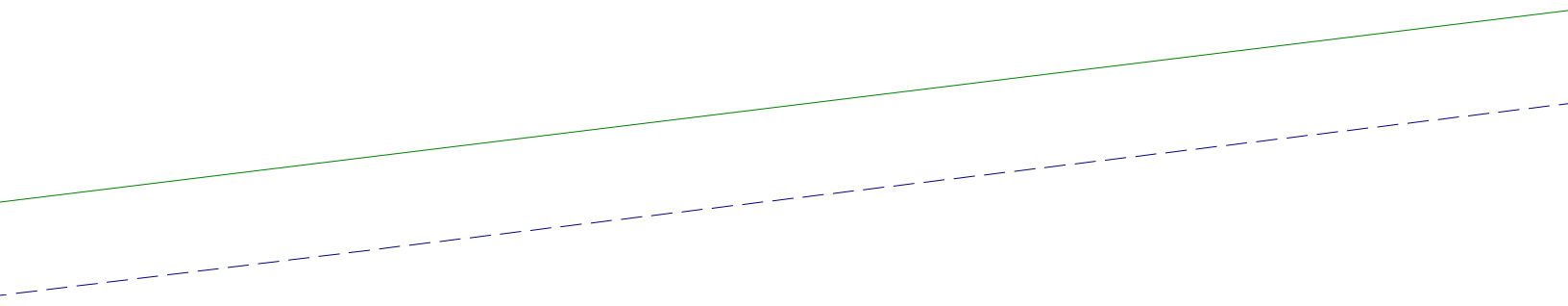

Center Back

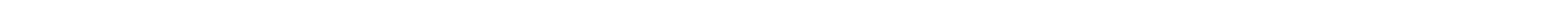

sew be it studio

Center Fro

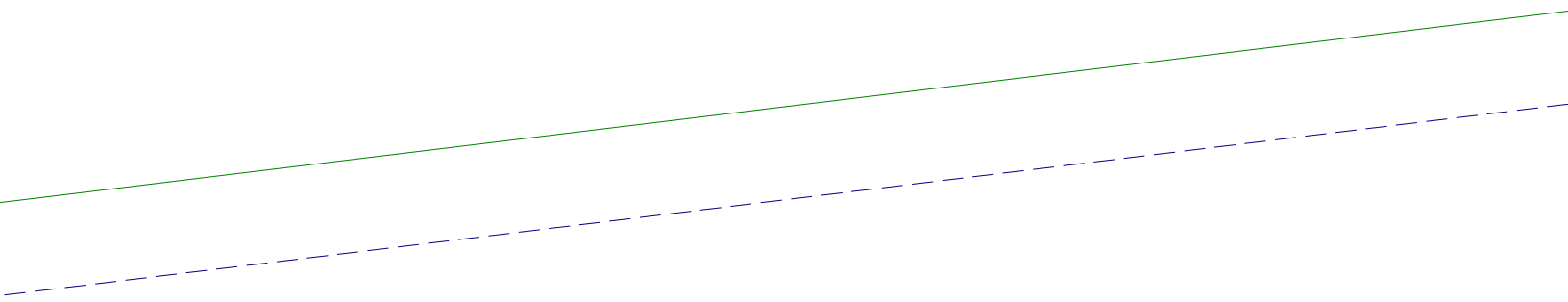

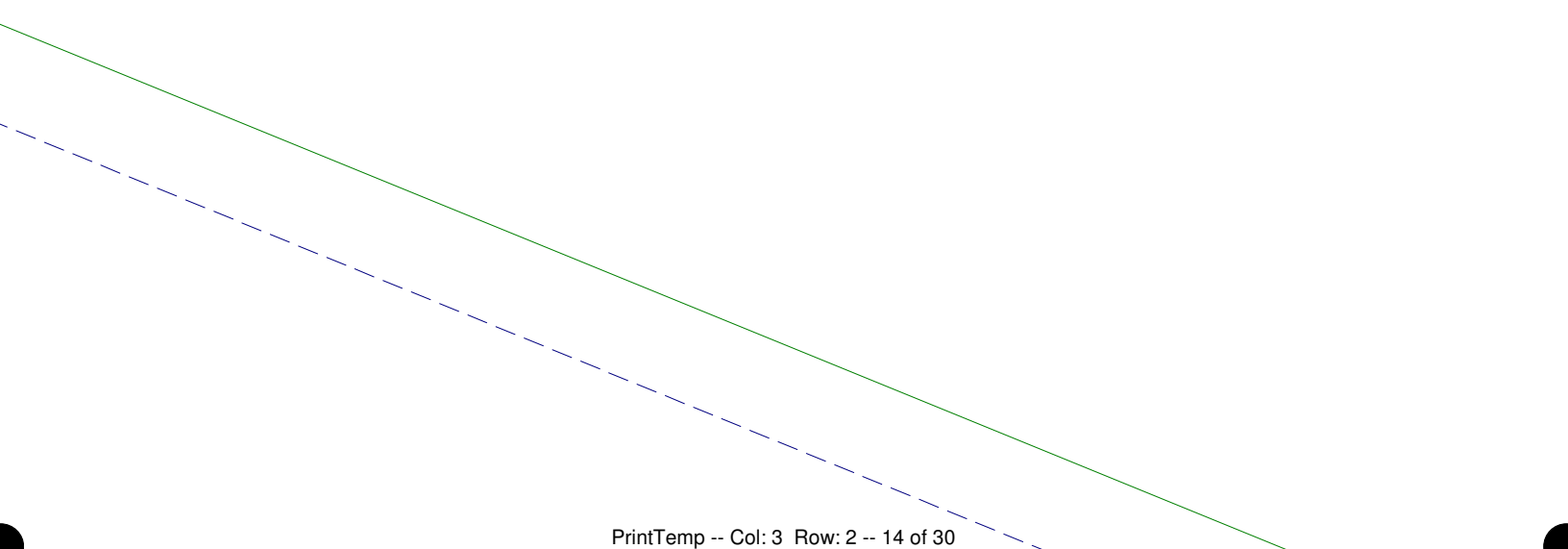
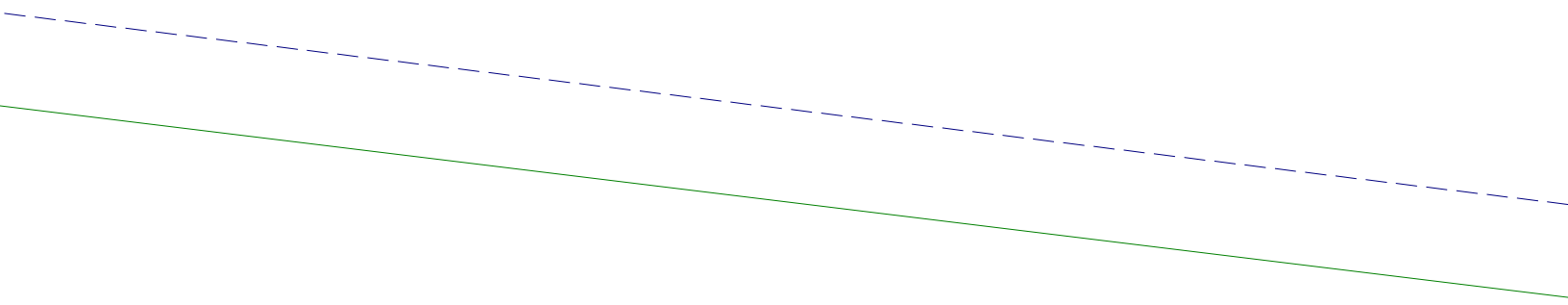

New Fa

Side Fro

Cut 2

Size 10

sew be

Full skirt

Front and side back

Fit studio

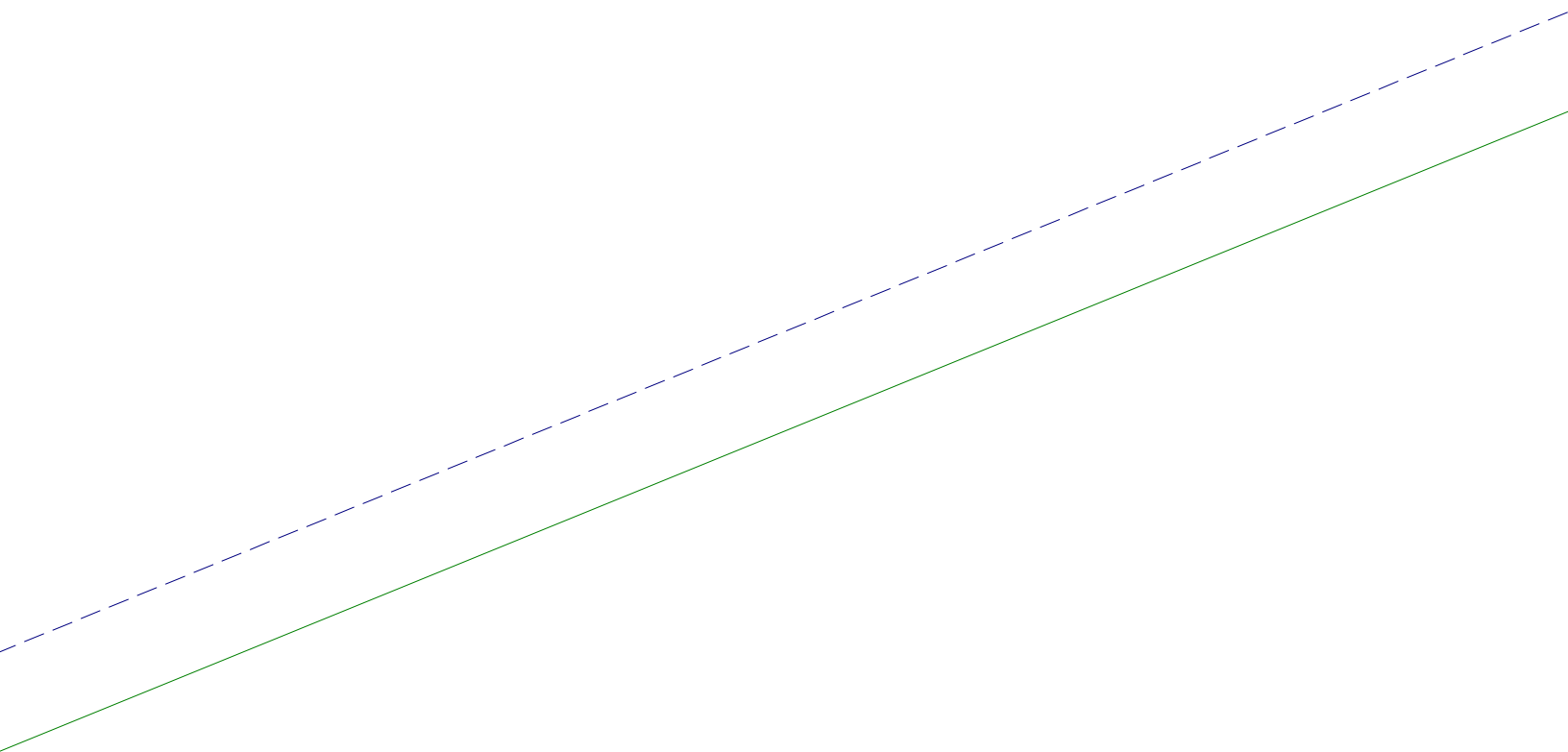

fold line

New fall skirt

Center back

Cut 2

Size 10

sew be it studio

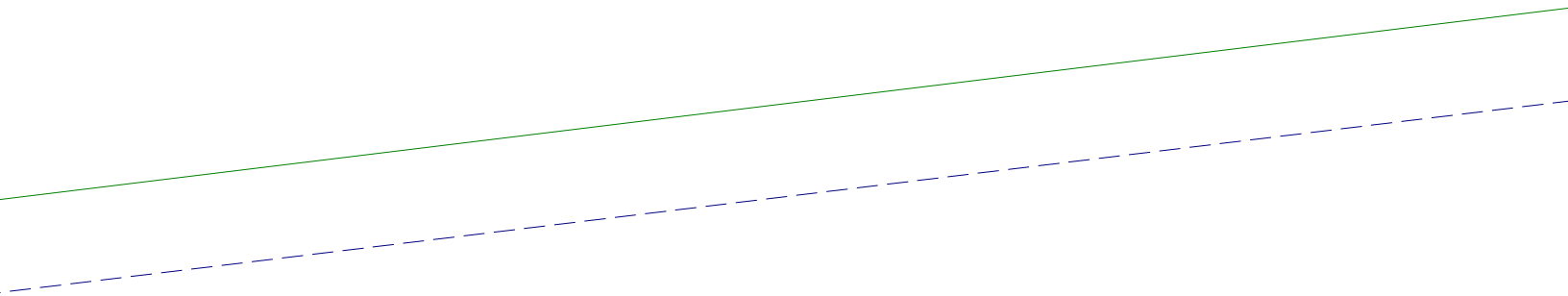

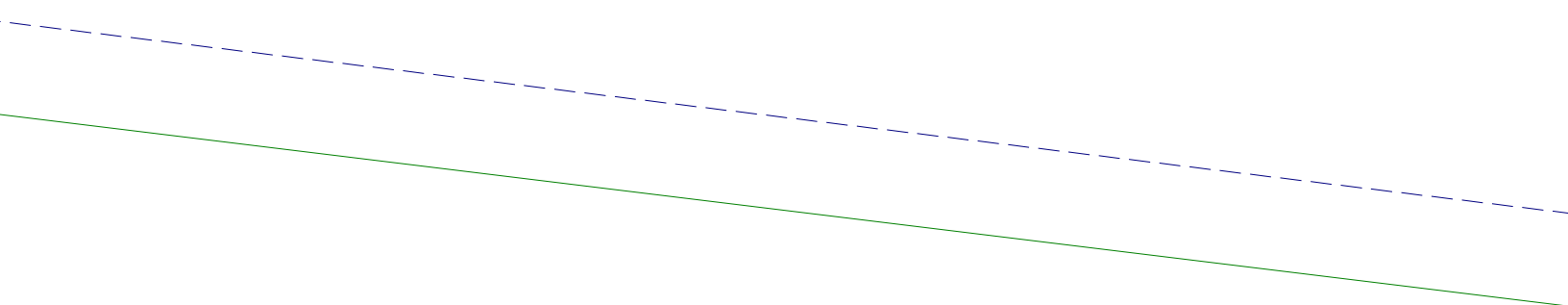

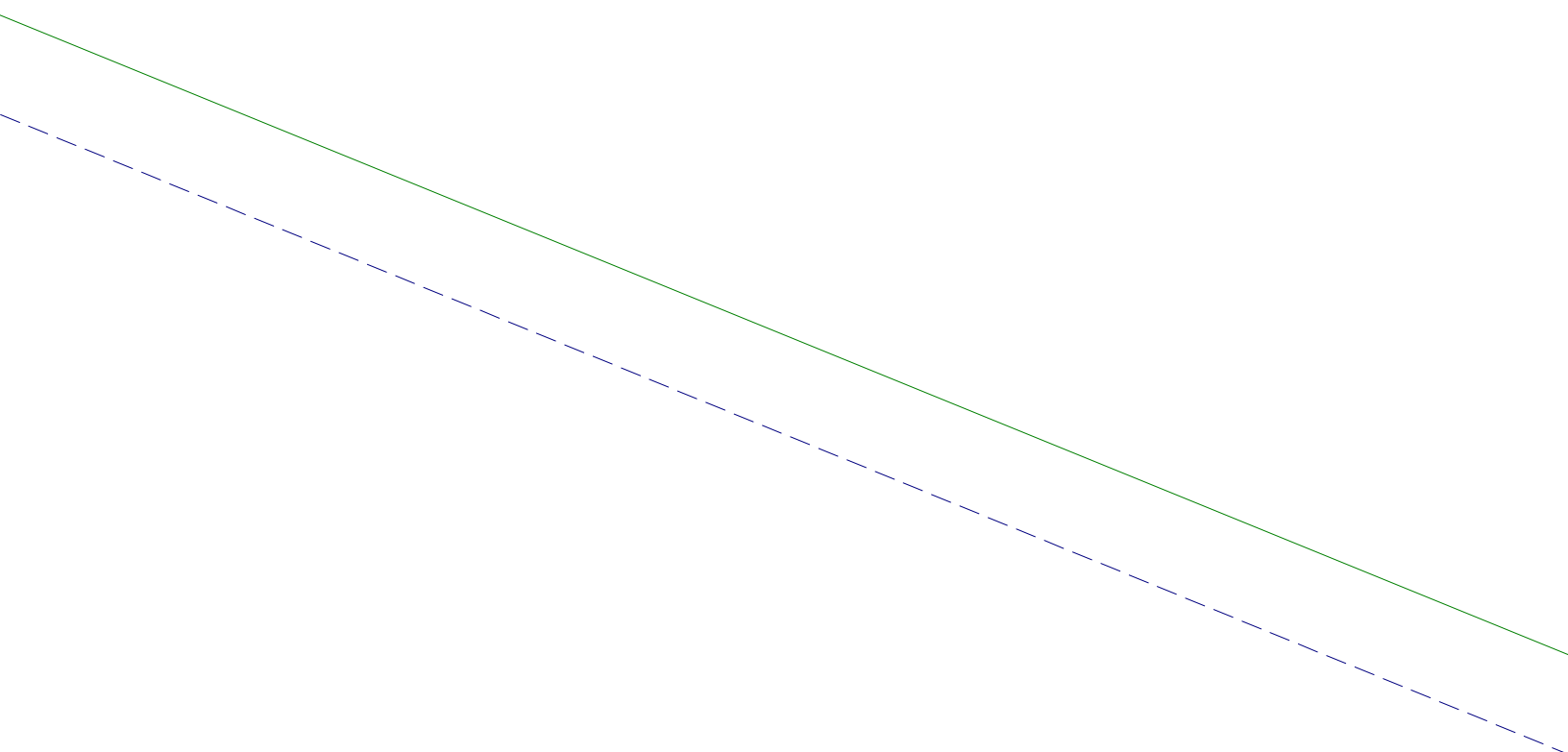

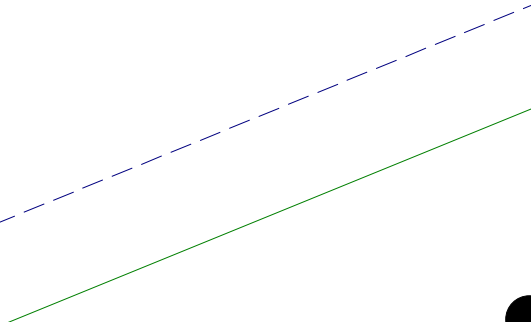
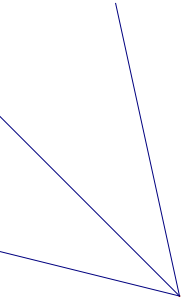

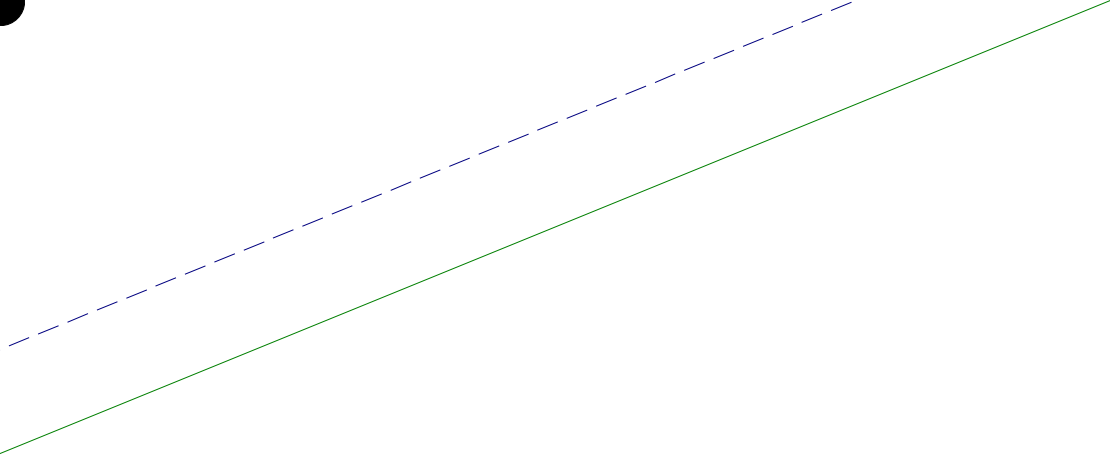

center front

New Fall skirt

Waistband
Cut 1 fabric
Cut 1 Interfacing
Size 10

sew be it studio

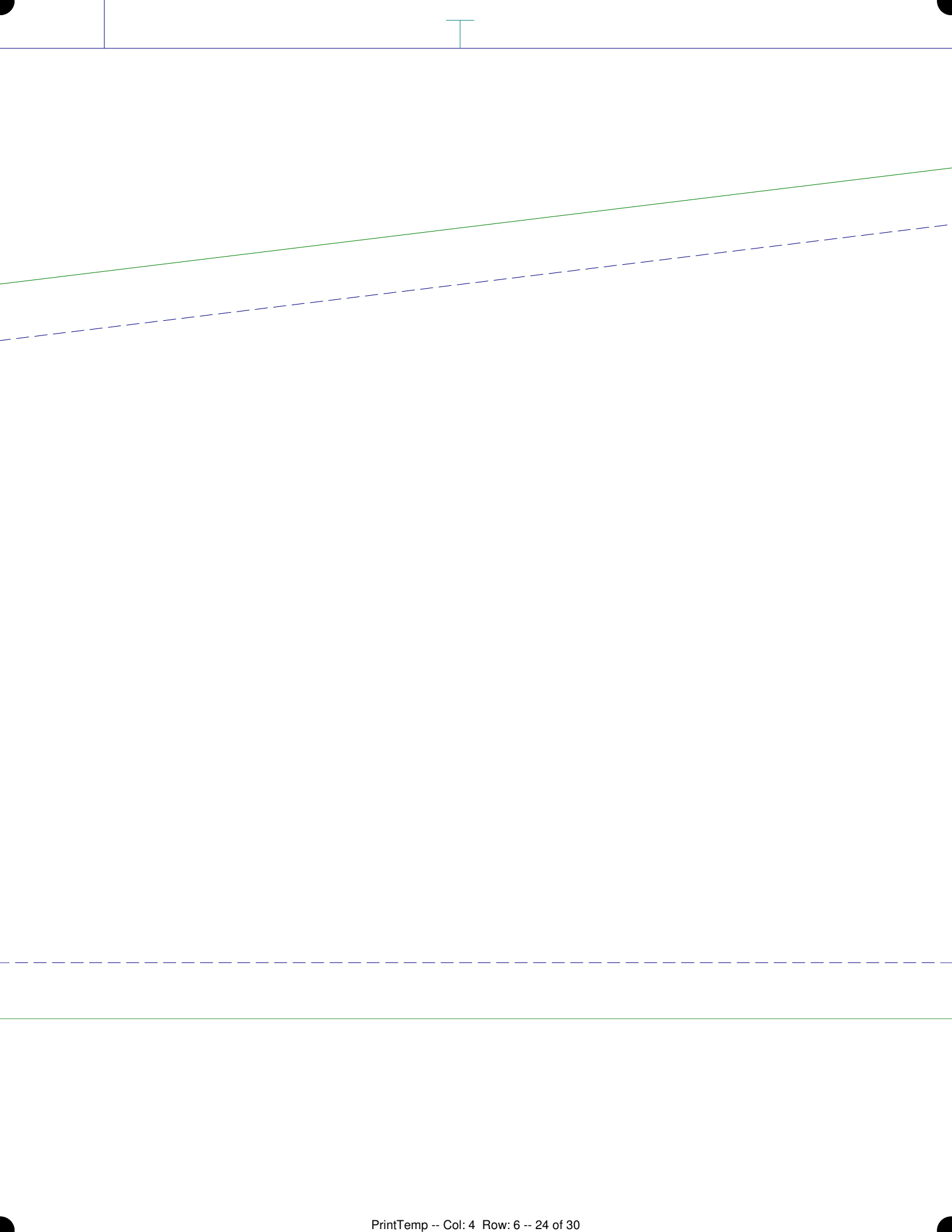

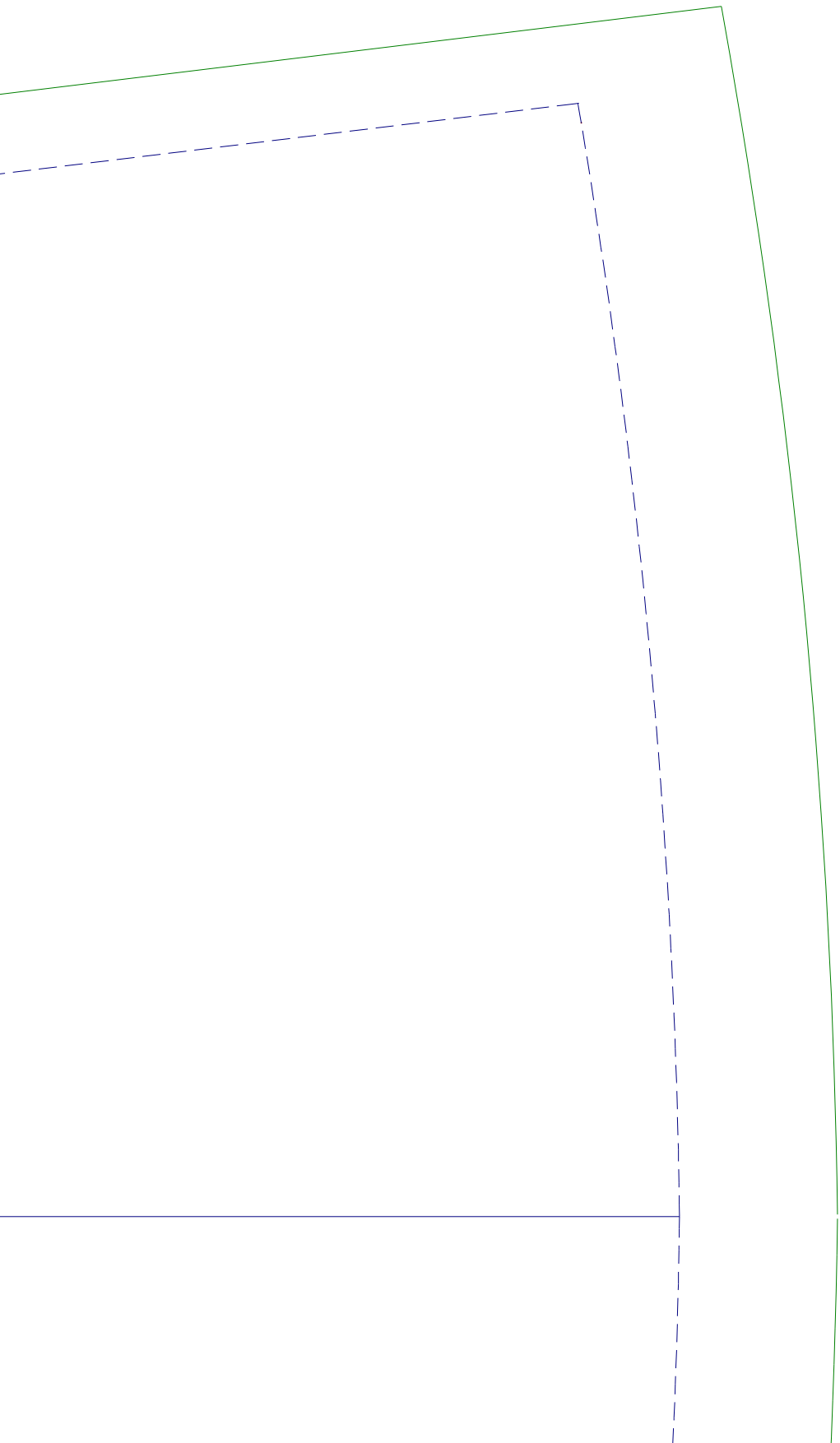

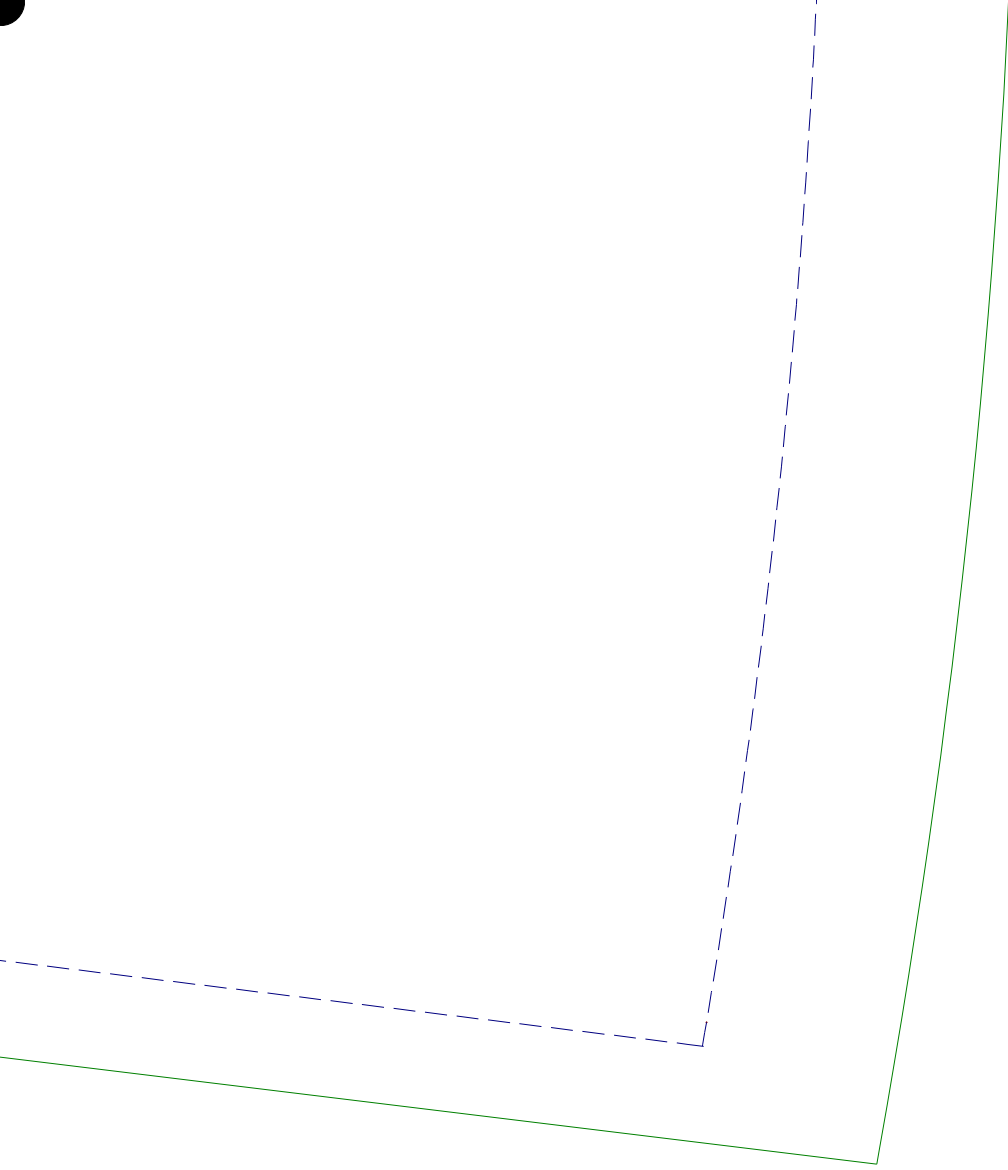

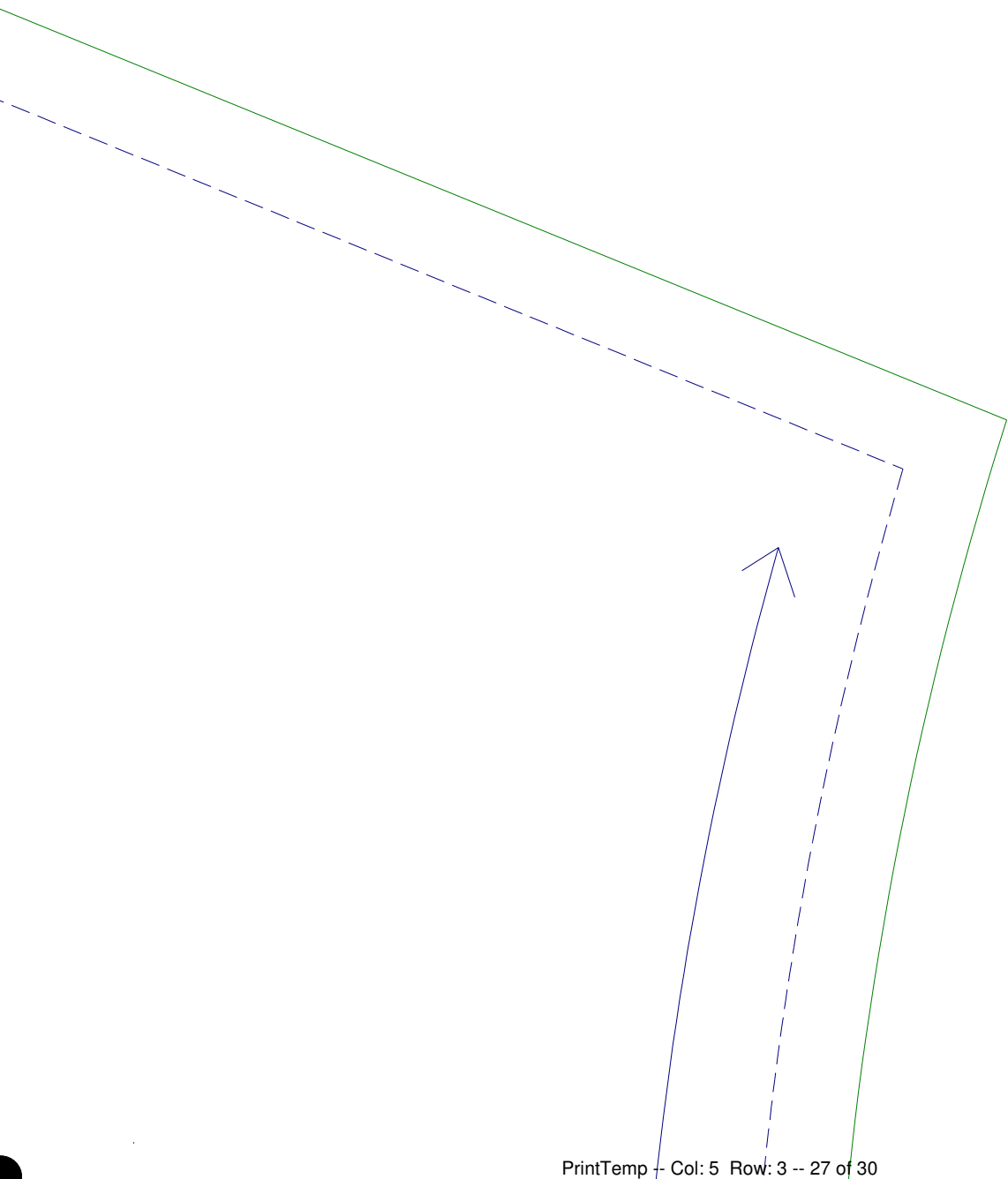

Gather



A large rectangular area defined by a solid green border. Inside this area, there is a dashed blue border. A horizontal dotted line is drawn across the width of the dashed blue area, approximately one-third of the way down from the top of the dashed area.

T

